

FDMA430NZ

Single N-Channel 2.5V Specified PowerTrench® MOSFET

30V, 5.0A, 40mΩ

General Description

This Single N-Channel MOSFET has been designed using Fairchild Semiconductor's advanced Power Trench process to optimize the $R_{DS(on)}$ @ $V_{GS}=2.5V$ on special MicroFET leadframe.

Applications

- Li-Ion Battery Pack



Features

- $R_{DS(on)} = 40m\Omega$ @ $V_{GS} = 4.5V$, $I_D = 5.0A$
- $R_{DS(on)} = 50m\Omega$ @ $V_{GS} = 2.5V$, $I_D = 4.5A$
- Low Profile-0.8mm maximum-in the new package MicroFET 2x2 mm
- HBM ESD protection level > 2.5kV typical (Note 3)
- RoHS Compliant

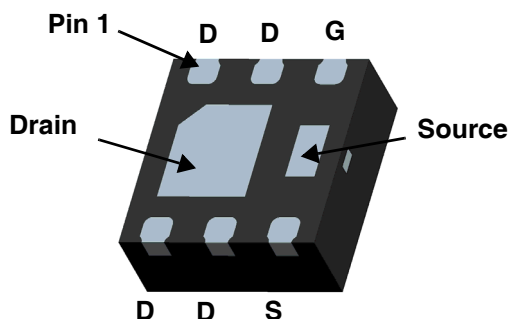

MicroFET 2X2 (Bottom View)

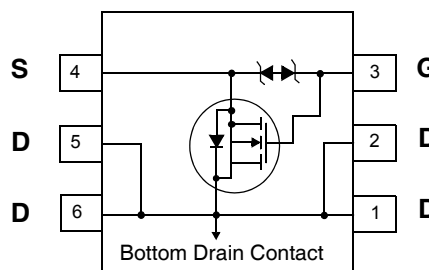

Absolute Maximum Ratings $T_A = 25^\circ C$ unless otherwise noted

Symbol	Parameter	Rated	Units
V_{DSS}	Drain-Source Voltage	30	V
V_{GSS}	Gate-Source Voltage	± 12	V
I_D	Drain Current -Continuous (Note 1a) -Pulsed	5.0	A
		20	
P_D	Power dissipation (Steady State) (Note 1a) (Note 1b)	0.9	W
		2.4	
T_J, T_{STG}	Operating and Storage Junction Temperature Range	-55 to +150	$^\circ C$

Thermal Characteristics

$R_{\theta JA}$	Thermal Resistance, Junction-to-Ambient (Note 1a)	145	$^\circ C/W$
$R_{\theta JA}$	Thermal Resistance, Junction-to-Ambient (Note 1b)	52	

Package Marking and Ordering Information

Device Marking	Device	Reel Size	Tape Width	Quantity
430	FDMA430NZ	7"	12mm	3000 units

Electrical Characteristics $T_J = 25^\circ\text{C}$ unless otherwise noted

Symbol	Parameter	Test Conditions	Min	Typ	Max	Units
--------	-----------	-----------------	-----	-----	-----	-------

Off Characteristics

B_{VDSS}	Drain-Source Breakdown Voltage	$V_{GS} = 0V, I_D = 250\mu A$	30			V
$\frac{\Delta B_{VDSS}}{\Delta T_J}$	Breakdown Voltage Temperature Coefficient	$I_D = 250\mu A$, Referenced to 25°C		25.2		mV/ $^\circ\text{C}$
I_{DSS}	Zero Gate Voltage Drain Current	$V_{DS} = 24V, V_{GS} = 0V$,			1	μA
I_{GSS}	Gate-Body Leakage,	$V_{GS} = \pm 12V, V_{DS} = 0V$			± 10	μA

On Characteristics (Note 2)

$V_{GS(th)}$	Gate Threshold Voltage	$V_{DS} = V_{GS}, I_D = 250\mu A$	0.6	0.81	1.5	V
$\frac{\Delta V_{GS(th)}}{\Delta T_J}$	Gate Threshold Voltage Temperature Coefficient	$I_D = 250\mu A$, Referenced to 25°C		-3.2		mV/ $^\circ\text{C}$
$R_{DS(on)}$	Static Drain-Source On-Resistance	$V_{GS} = 4.5V, I_D = 5.0A$		23.6	40	m Ω
		$V_{GS} = 4.0V, I_D = 5.0A$		23.9	41	
		$V_{GS} = 3.1V, I_D = 4.5A$		25.4	43	
		$V_{GS} = 2.5V, I_D = 4.5A$		27.6	50	
		$V_{GS} = 4.5V, I_D = 5.0A$, $T_J = 150^\circ\text{C}$		37.0	61	
g_{FS}	Forward Transconductance	$V_{DS} = 5V, I_D = 5.0A$		25.6		S

Dynamic Characteristics

C_{iss}	Input Capacitance	$V_{DS} = 10V, V_{GS} = 0V$, $f = 1.0\text{MHz}$		600	800	pF
C_{oss}	Output Capacitance			110	150	pF
C_{rss}	Reverse Transfer Capacitance			75	115	pF
R_G	Gate Resistance	$f = 1.0\text{MHz}$		3.5		Ω

Switching Characteristics (Note 2)

$t_{d(on)}$	Turn-On Delay Time	$V_{DD} = 10V, I_D = 1A$ $V_{GS} = 4.5V, R_{GEN} = 6\Omega$		8.3	17	ns
t_r	Turn-On Rise Time			7.1	15	ns
$t_{d(off)}$	Turn-Off Delay Time			18.1	37	ns
t_f	Turn-Off Fall Time			6.0	12	ns
Q_g	Total Gate Charge	$V_{DS} = 10V, I_D = 5.0A$, $V_{GS} = 4.5V$		7.3	11	nC
Q_{gs}	Gate-Source Charge			0.8	2	nC
Q_{gd}	Gate-Drain Charge			1.9	3	nC

Drain-Source Diode Characteristics and Maximum Ratings

I_S	Maximum Continuous Drain-Source Diode Forward Current			2.0	A
V_{SD}	Drain-Source Diode Forward Voltage	$V_{GS} = 0V, I_S = 2.0A$	0.69	1.2	V
t_{rr}	Diode Reverse Recovery Time	$I_F = 5.0A$,		17	ns
Q_{rr}	Diode Reverse Recovery Charge	$di/dt = 100A/\mu s$		5	nC

Notes:

- $R_{\theta JA}$ is the sum of the junction-to-case and case-to-ambient thermal resistance where the case thermal reference is defined as the solder mounting surface of the drain pins.
 - 145°C/W when mounted on a minimum pad of 2 oz copper
 - 52°C/W when mounted on a 1 in² pad of 2 oz copper
- Pulse Test: Pulse Width < 300 μs , Duty Cycle < 2.0%
- The diode connected between the gate and the source serves only as protection against ESD. No gate overvoltage rating is implied.

Typical Characteristics $T_J = 25^\circ\text{C}$ unless otherwise noted

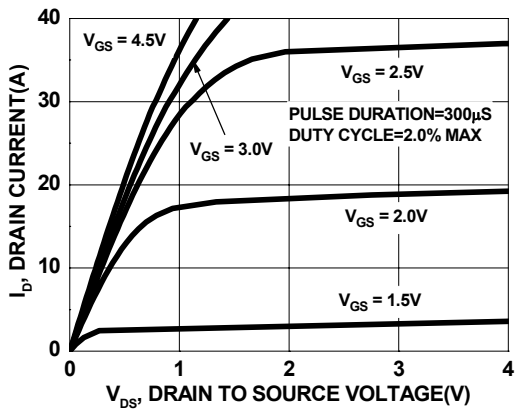

Figure 1. On Region Characteristics

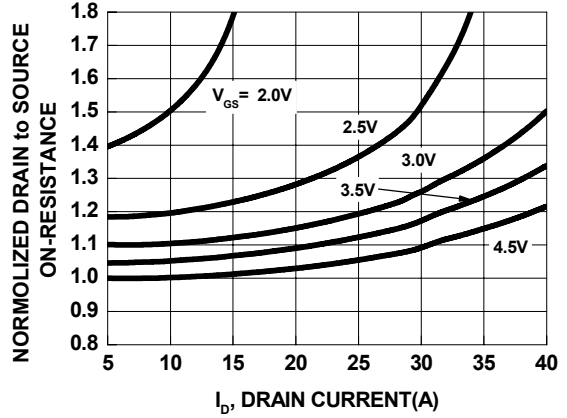

Figure 2. On-Resistance vs Drain Current and Gate Voltage

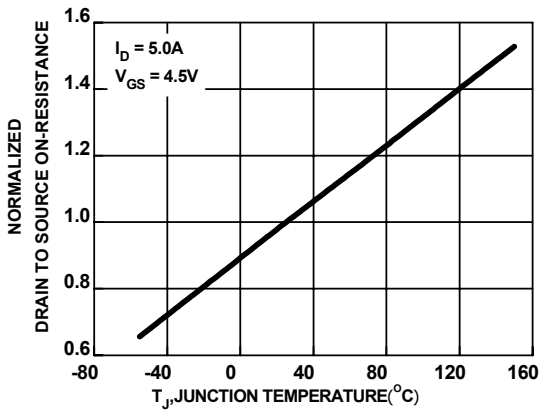

Figure 3. Normalized On Resistance vs Junction Temperature

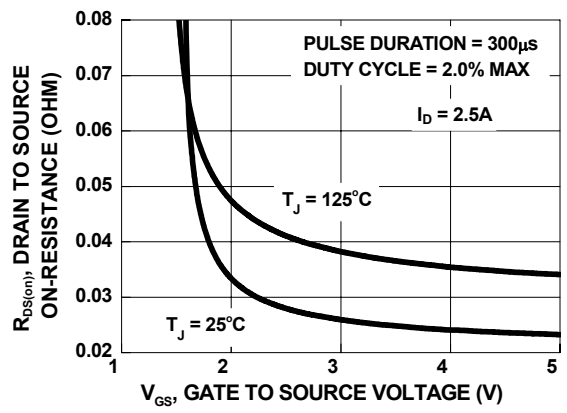

Figure 4. On-Resistance vs Gate to Source Voltage

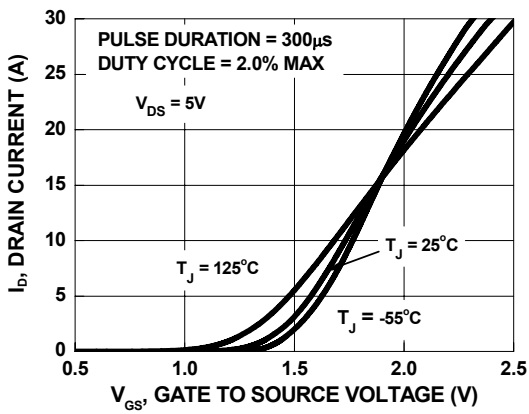

Figure 5. Transfer Characteristics

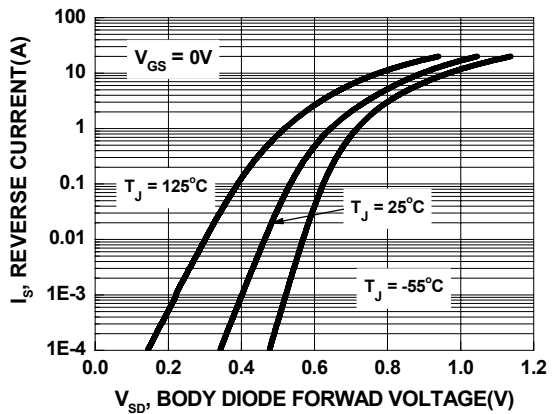

Figure 6. Source to Drain Diode Forward Voltage vs Source Current

Typical Characteristics $T_J = 25^\circ\text{C}$ unless otherwise noted

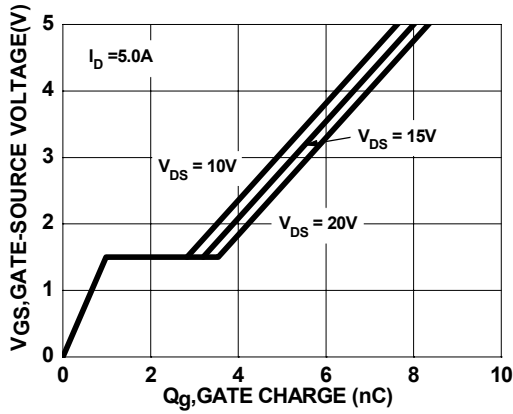

Figure 7. Gate Charge Characteristics

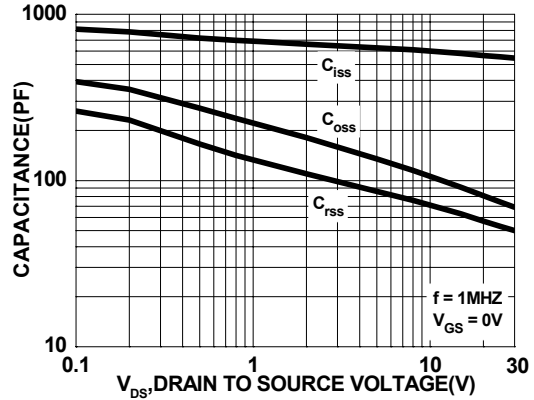

Figure 8. Capacitance vs Drain to Source Voltage

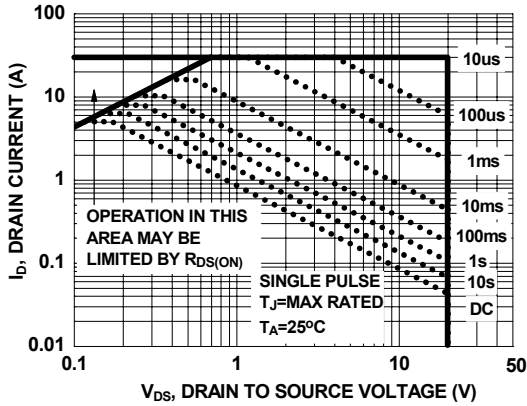

Figure 9. Safe Operating Area

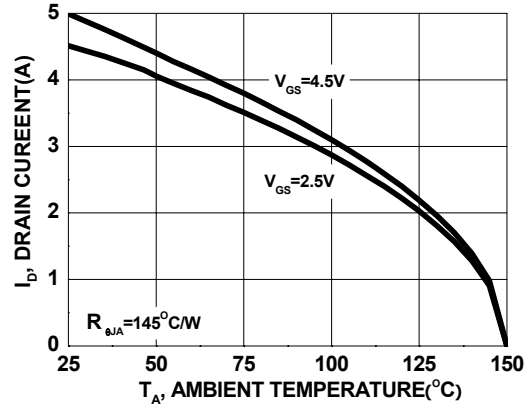

Figure 10. Maximum Continuous Drain Current vs Ambient Temperature

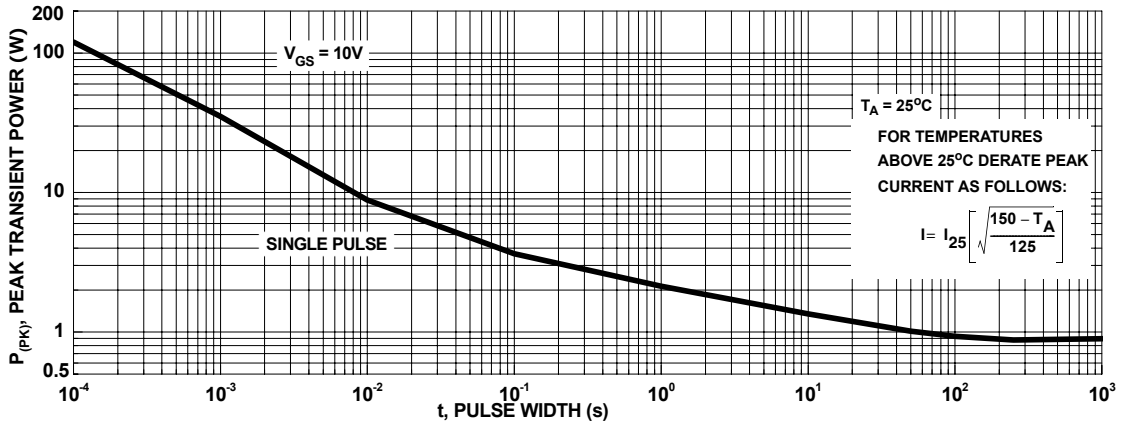

Figure 11. Single Pulse Maximum Power Dissipation

Typical Characteristics $T_J = 25^\circ\text{C}$ unless otherwise noted

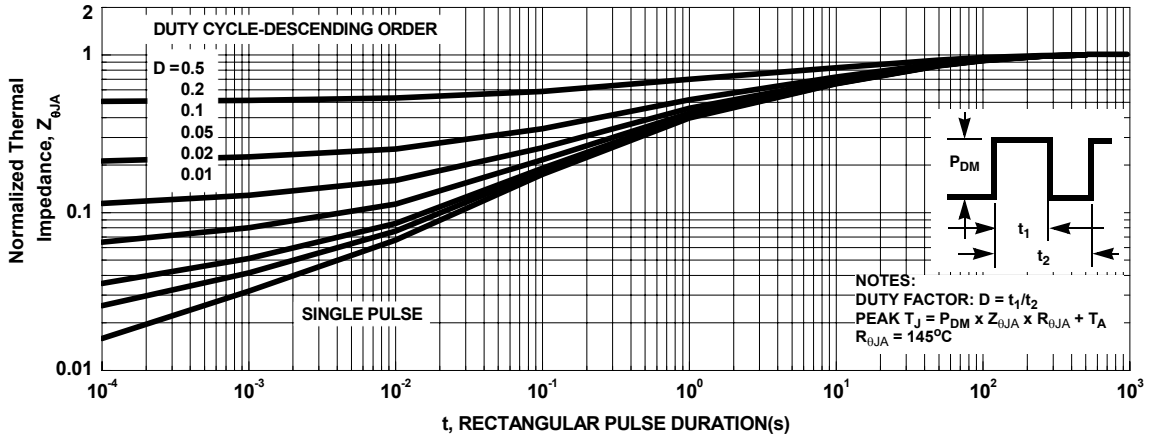
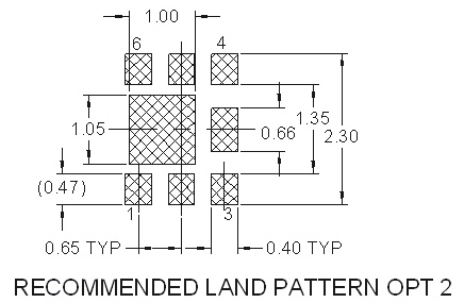
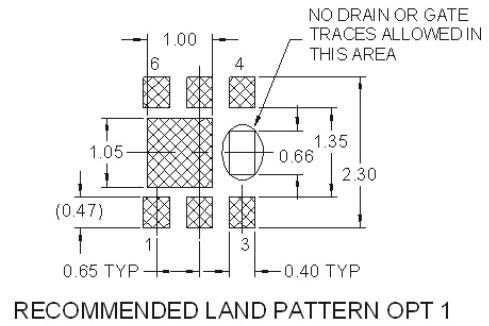
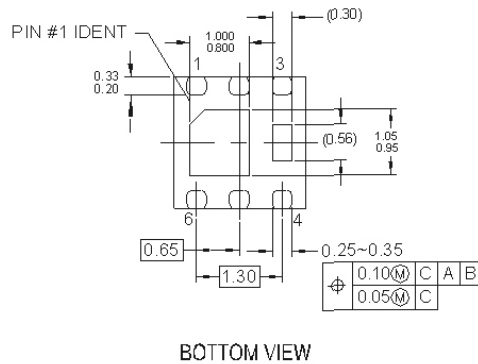
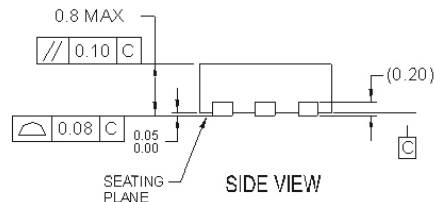
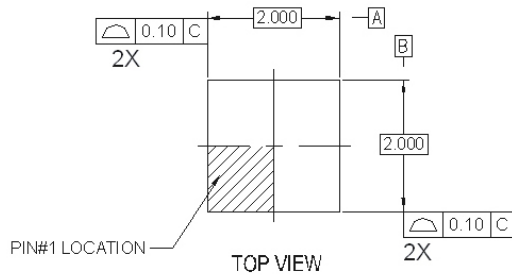

Figure 12. Transient Thermal Response Curve

Dimensional Outline and Pad Layout





NOTES:

- A. DOES NOT FULLY CONFORM TO JEDEC REGISTRATION MO-229 DATED AUG/2003
- B. DIMENSIONS ARE IN MILLIMETERS.
- C. DIMENSIONS AND TOLERANCES PER ASME Y14.5M, 1994
- D. DRAWING FILENAME: MKT-MLP06Lrev2.



TRADEMARKS

The following includes registered and unregistered trademarks and service marks, owned by Fairchild Semiconductor and/or its global subsidiaries, and is not intended to be an exhaustive list of all such trademarks.

- | | | | |
|---|---|---|---|
| ACEx® | FPS™ | PDP-SPM™ | The Power Franchise® |
| Build it Now™ | F-PFS™ | Power-SPM™ | power
the franchise |
| CorePLUS™ | FRFET® | PowerTrench® | TinyBoost™ |
| CorePOWER™ | Global Power ResourceSM | Programmable Active Droop™ | TinyBuck™ |
| CROSSVOLT™ | Green FPS™ | QFET® | TinyLogic® |
| CTL™ | Green FPS™ e-Series™ | QS™ | TINYOPTO™ |
| Current Transfer Logic™ | GTO™ | Quiet Series™ | TinyPower™ |
| EcoSPARK® | IntelliMAX™ | RapidConfigure™ | TinyPWM™ |
| EfficientMax™ | ISOPLANAR™ | Saving our world 1mW at a time™ | TinyWire™ |
| EZSWITCH™ * | MegaBuck™ | SmartMax™ | µSerDes™ |
|  | MICROCOUPLER™ | SMART START™ |  |
|  | MicroFET™ | SPM® | UHC® |
| Fairchild® | MicroPak™ | STEALTH™ | Ultra FRFET™ |
| Fairchild Semiconductor® | MillerDrive™ | SuperFET™ | UniFET™ |
| FACT Quiet Series™ | MotionMax™ | SuperSOT™-3 | VCX™ |
| FACT® | Motion-SPM™ | SuperSOT™-6 | VisualMax™ |
| FAST® | OPTOLOGIC® | SuperSOT™-8 | |
| FastvCore™ | OPTOPLANAR® | SuperMOS™ | |
| FlashWriter® * |  |  | |

* EZSWITCH™ and FlashWriter® are trademarks of System General Corporation, used under license by Fairchild Semiconductor.

DISCLAIMER

FAIRCHILD SEMICONDUCTOR RESERVES THE RIGHT TO MAKE CHANGES WITHOUT FURTHER NOTICE TO ANY PRODUCTS HEREIN TO IMPROVE RELIABILITY, FUNCTION, OR DESIGN. FAIRCHILD DOES NOT ASSUME ANY LIABILITY ARISING OUT OF THE APPLICATION OR USE OF ANY PRODUCT OR CIRCUIT DESCRIBED HEREIN; NEITHER DOES IT CONVEY ANY LICENSE UNDER ITS PATENT RIGHTS, NOR THE RIGHTS OF OTHERS. THESE SPECIFICATIONS DO NOT EXPAND THE TERMS OF FAIRCHILD'S WORLDWIDE TERMS AND CONDITIONS, SPECIFICALLY THE WARRANTY THEREIN, WHICH COVERS THESE PRODUCTS.

LIFE SUPPORT POLICY

FAIRCHILD'S PRODUCTS ARE NOT AUTHORIZED FOR USE AS CRITICAL COMPONENTS IN LIFE SUPPORT DEVICES OR SYSTEMS WITHOUT THE EXPRESS WRITTEN APPROVAL OF FAIRCHILD SEMICONDUCTOR CORPORATION.

As used herein:

- Life support devices or systems are devices or systems which, (a) are intended for surgical implant into the body or (b) support or sustain life, and (c) whose failure to perform when properly used in accordance with instructions for use provided in the labeling, can be reasonably expected to result in a significant injury of the user.
- A critical component in any component of a life support, device, or system whose failure to perform can be reasonably expected to cause the failure of the life support device or system, or to affect its safety or effectiveness.

PRODUCT STATUS DEFINITIONS

Definition of Terms

Datasheet Identification	Product Status	Definition
Advance Information	Formative or In Design	This datasheet contains the design specifications for product development. Specifications may change in any manner without notice.
Preliminary	First Production	This datasheet contains preliminary data; supplementary data will be published at a later date. Fairchild Semiconductor reserves the right to make changes at any time without notice to improve design.
No Identification Needed	Full Production	This datasheet contains final specifications. Fairchild Semiconductor reserves the right to make changes at any time without notice to improve the design.
Obsolete	Not In Production	This datasheet contains specifications on a product that is discontinued by Fairchild Semiconductor. The datasheet is for reference information only.